

V

Eadie

collection

20
24



House Collection

Eadie 900 Single

Eadie 1500 Double

Chelsea 460

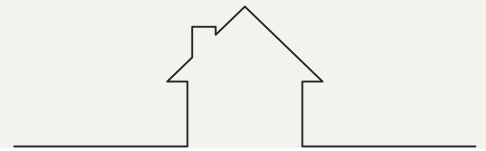

House Collection



Eadie 900 Single



Eadie 1500 Double



Chelsea 460

Cabinet Finish

Choose your Paint Finish | Custom Paint

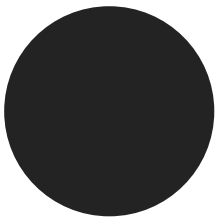

Black

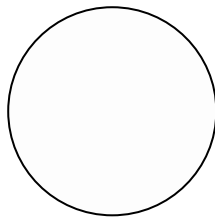

White

Basin

Client to Nominate



Tommy White or Black (Standard)

Bench Top

Subject to availability and chosen design



Snow-Blanc
Crystalline Silica-Free (Engineered Stone)



Ayla
Crystalline Silica-Free (Engineered Stone)

Handles

Choose a finish



Brushed Gold



Brushed Nickel



Eadie collection

– The Eadie boasts a modern design, with sleek paint finish available in Black, White & Custom Paint colours. These finishes are meticulously applied with a delicate scalloped pattern, evoking the opulence of Art Deco-inspired spaces. Embrace the coastal allure reminiscent of 'The Great Gatsby' as you indulge in the sophistication of scallop shell motifs.

Eadie 900 | Single Basin

900 Length x 460 Depth

Eadie 1500 | Double Basin

1500 Length x 460 Depth



Eadie



Eadie 900 Single - 2024

Cabinet Size: 880mm (L) X 450mm (D) X 500mm (H)

Top Size: 900mm (L) X 460mm (D) X 20mm (H)

Type: Wall Hung

Basin: Client to nominate

No Tap Holes, Tapware to be wall-mounted

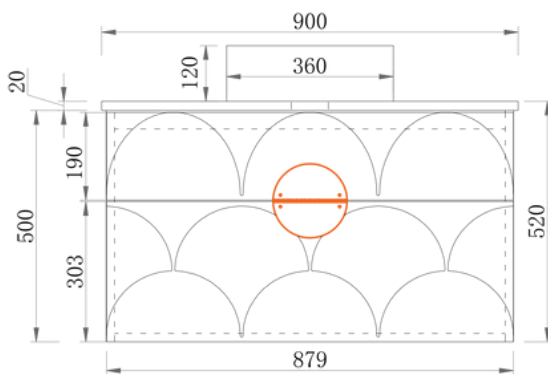
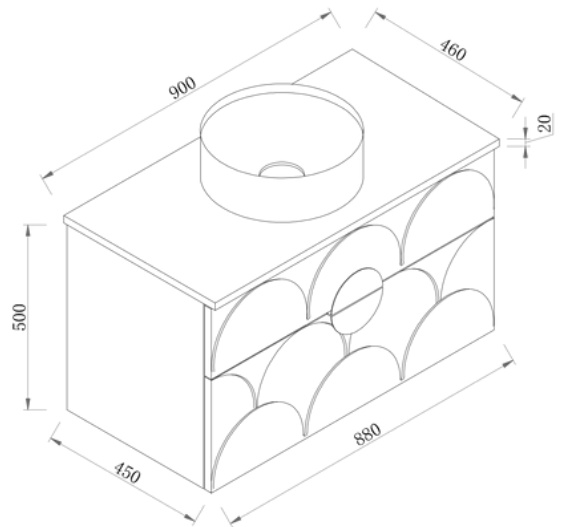

Front Elevation

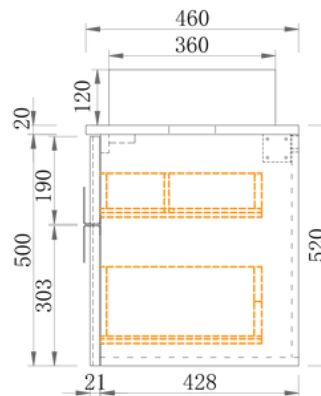

Section Side

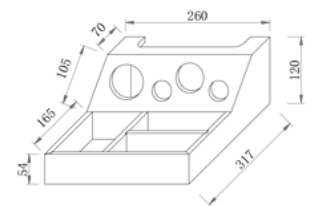

Hairdryer Insert
(Lower Drawer)

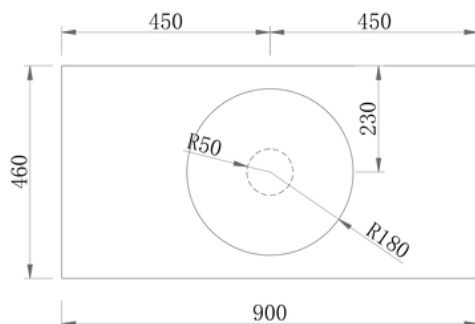

Top View

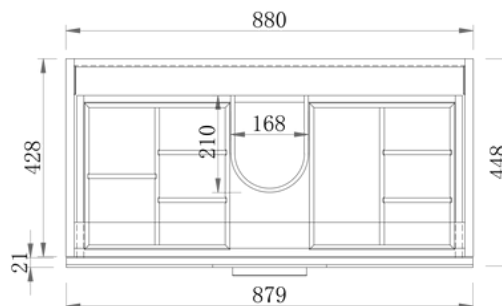

Section Top - Drawer Inserts

Notes:

- Wastes and faucets are not included.
- Vanity unit must be installed by a qualified tradesmen - Failure to do so will void the warranty.
- Plumbing fixtures must be installed by a qualified plumber - Failure to do so will void the warranty.
- Warranty information: 5 years on cabinet & 12 months on top and basin(s).
- Caution boxes may be heavy and will require 2 people to lift.



vanitybydesign.com.au



[vanitybydesign_](https://www.instagram.com/vanitybydesign_)



TEL: 07 [3376 6055](tel:33766055)



241 Monier Road
Darra, QLD, 4076

Eadie



Eadie 1500 Double - 2024

Cabinet Size: 1480mm (L) X 450mm (D) X 500mm (H)
Top Size: 1500mm (L) X 460mm (D) X 20mm (H)
Type: Wall Hung
Basin: Client to nominate
No Tap Holes, Tapware to be wall-mounted

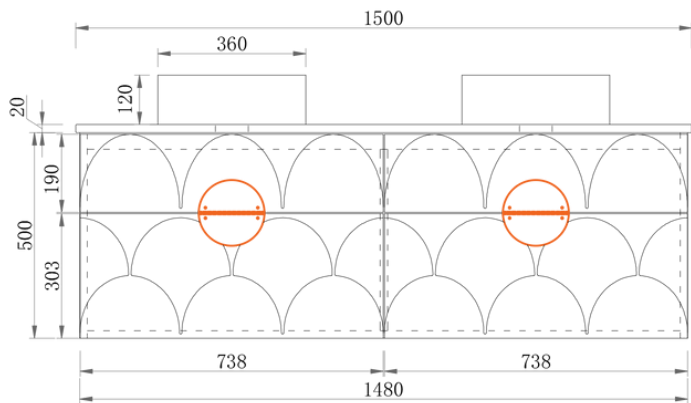
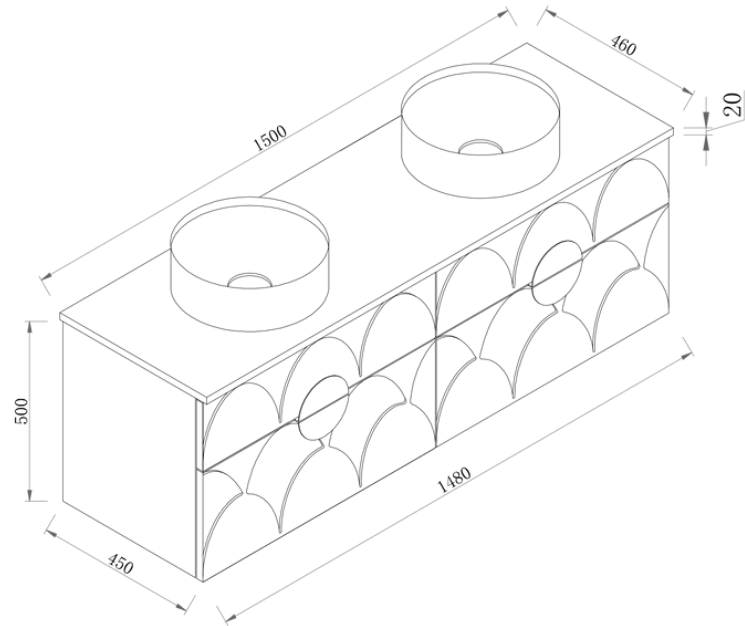

Front Elevation

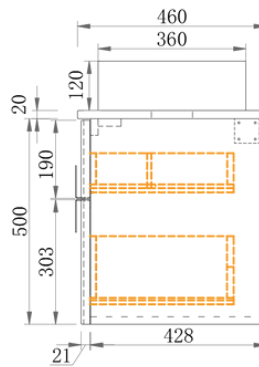

Section Side

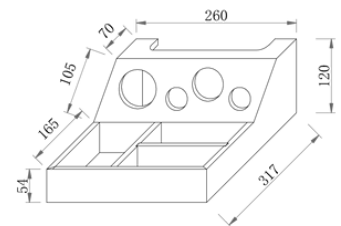

Hairdryer Insert
(Lower Drawer)

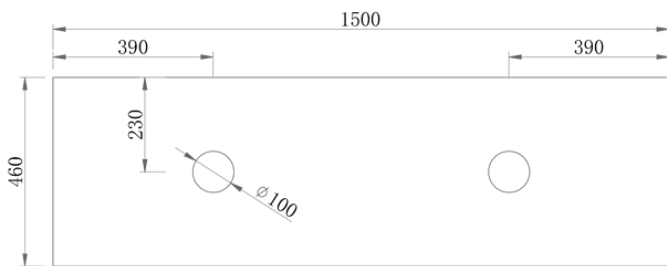

Top View

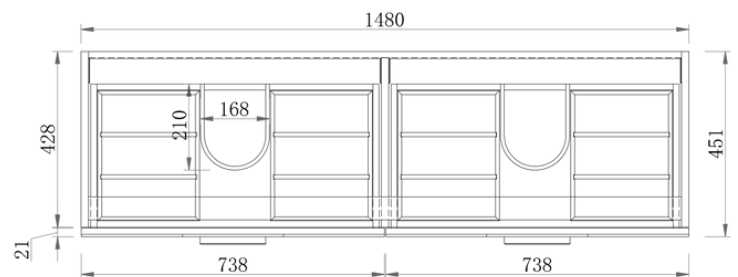

Section Top - Drawer Inserts

Notes:

- Wastes and faucets are not included.
- Vanity unit must be installed by a qualified tradesmen - Failure to do so will void the warranty.
- Plumbing fixtures must be installed by a qualified plumber - Failure to do so will void the warranty.
- Warranty information: 5 years on cabinet & 12 months on top and basin(s).
- Caution boxes may be heavy and will require 2 people to lift.



vanitybydesign.com.au



vanitybydesign_



TEL: 07 3376 6055



241 Monier Road
Darra, QLD, 4076



Chelsea

Chelsea 460

Overall Size: 460mm (L) X 255mm (D) X 600mm (H)

Type: Wall-Hung

*Only Suitable for Mixer Tap

Finish - Natural, Japan Black & Custom Paint

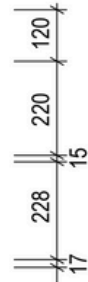
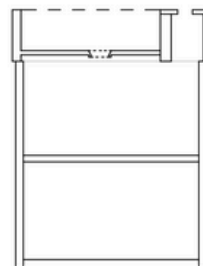
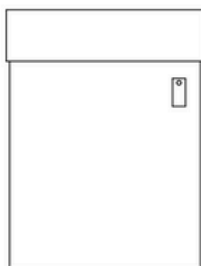
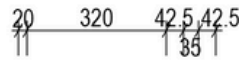
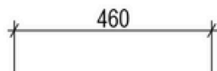
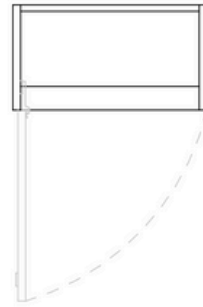
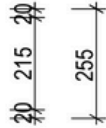
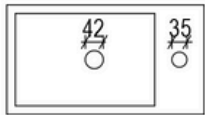
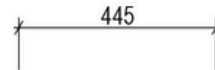
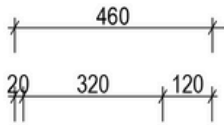
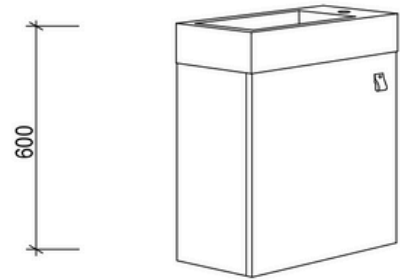

Notes:

- Wastes and faucets are not included.
- Vanity unit must be installed by a qualified tradesmen - Failure to do so will void the warranty.
- Plumbing fixtures must be installed by a qualified plumber - Failure to do so will void the warranty.
- Warranty information: 5 years on cabinet & 12 months on top and basin(s).
- Caution boxes may be heavy and will require 2 people to lift.



vanitybydesign.com.au



[vanitybydesign_](https://www.instagram.com/vanitybydesign_)



TEL: 07 3376 6055



241 Monier Road
Darra, QLD, 4076

V



vanitybydesign.com.au



[vanitybydesign_](https://www.instagram.com/vanitybydesign_)



TEL: 07 3376 6055



241 Monier Road
Darra, QLD, 4076